

Dimensions (mm)

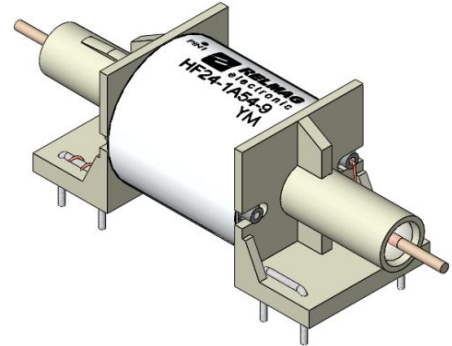

LAYOUT

pitch 2,54 mm / Top View

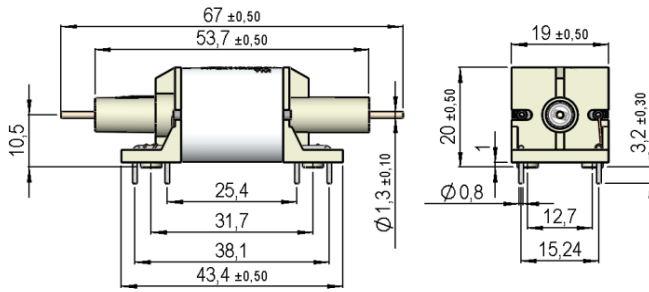
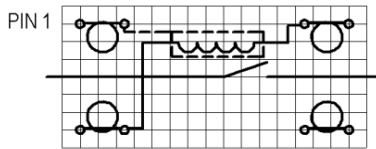

MARKING



Production Code EN 60062

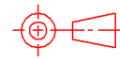

unspecified tolerances acc. to DIN ISO2768-m

Coil Data

Coil Resistance	at 20°C	+/-10 %	1000	Ohm
Coil Voltage			24	VDC
Thermal Resistance	Max. relay temperature = operating temp. + self heating		33	K/W
Rated Power			576	mW
Coil Current			24	mA
Inductance			-	mH
Pull-In Voltage	at 20°C	max.	18	VDC
Drop-Out Voltage	at 20°C	min.	3,5	VDC

Description

Reed Relay for switching Power High Frequency Applications

with High Frequency Shield

Normally Open - Form: A

Magnetic Shield

In compliance with REACH / RoHS

Contact Data

Contact Material			Rh / Cu	
Contact Number			54	
Contact Rating	Combination of voltage and current must not exceed maximal contact rating		25	W
Switching voltage	DC or AC peak		500	V
HF Switching Current	Arms @ 30 MHz		1,5	A
HF Carry Current	Arms @ 30 MHz		5	A
Static Contact Resistance	Measured with 40% Pull-In overdrive	max.	30	mOhm
Insulation Resistance	RH < 45 %, 100 V test voltage	min.	100	GOhm
Breakdown Voltage	according to IEC 255-5	min.	9	kV DC
Operating Time incl. bounce	measured with nom. voltage @ 20°C		3	ms
Release Time	measured without coil excitation		1,2	ms
Capacity	measured @ 10 kHz	max.	1	pF

Special Product Data

Insulation Resistance Coil/Contact	RH < 45 %, 200 V test voltage	min.	1	TOhm
Insulation Voltage Coil/Contact	according to IEC 255-5	min.	10	kV DC
Insulation Voltage Coil/Shield	according to IEC 255-5	min.	0,5	kV DC
Insulation Voltage Shield/Contact	according to IEC 255-5	min.	10	kV DC
Capacitance Coil/Contact			1,2	pF
Housing Material			Plastic PP / RF Shield	
Fixation of Switch			Silicon Sleeve	
Connection Pins			Copper alloy tin plated	

Environmental Data

Operating Temperature:	-40 ~ 85 °C
Storage Temperature:	-55 ~ 125 °C
Shock (1/2 sine wave 11 ms):	50 g
Vibration (10 - 2000 Hz):	20 g
Soldering Temp. (max. 5 s):	260°C
Cleaning:	fully sealed